

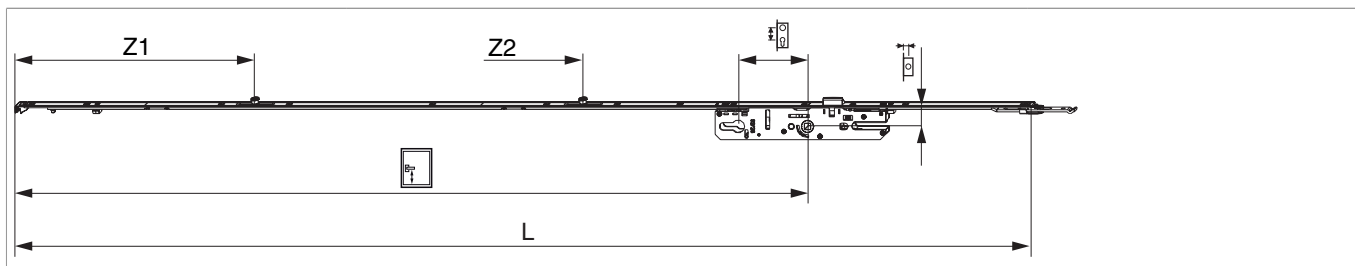

203831 - Serratura per portafinestra con scrocco con 2 funghi I92 per cilindro E45 argento MM L=1.347

Disegni tecnici



						L		Nº
MM fix	argento	45	8	1.050	92	1.347	5	203831 ¹⁾

¹⁾ Prolunghe frontali nel capitolo accessori

Tabella posizionamento viti

Nº										
203831	9	20	93	272	361	551	702	796	1.179	1.340

Tabella punti di chiusura

Nº		Z1	Z2	
203831	2	316	750	



203831 - Serratura per portafinestra con scrocco con 2
funghi I92 per cilindro E45 argento MM L=1.347

Schema foro e fresata

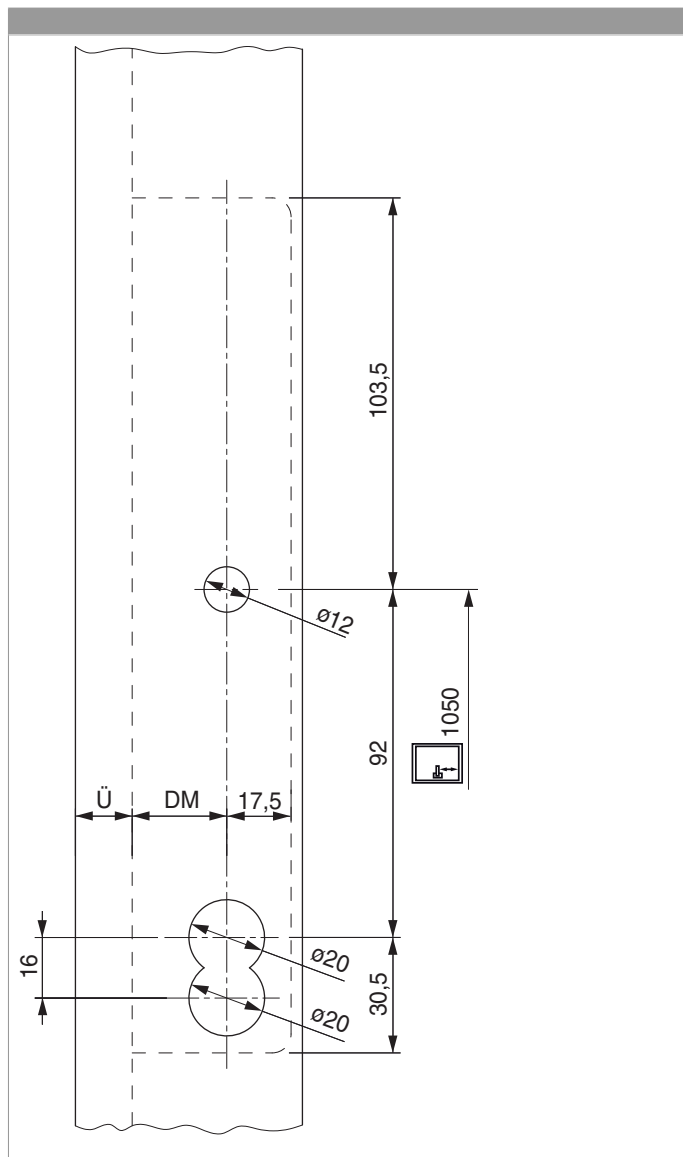



203831 - Serratura per portafinestra con scrocco con 2
funghi I92 per cilindro E45 argento MM L=1.347

Quote scatola serratura per portafinestra

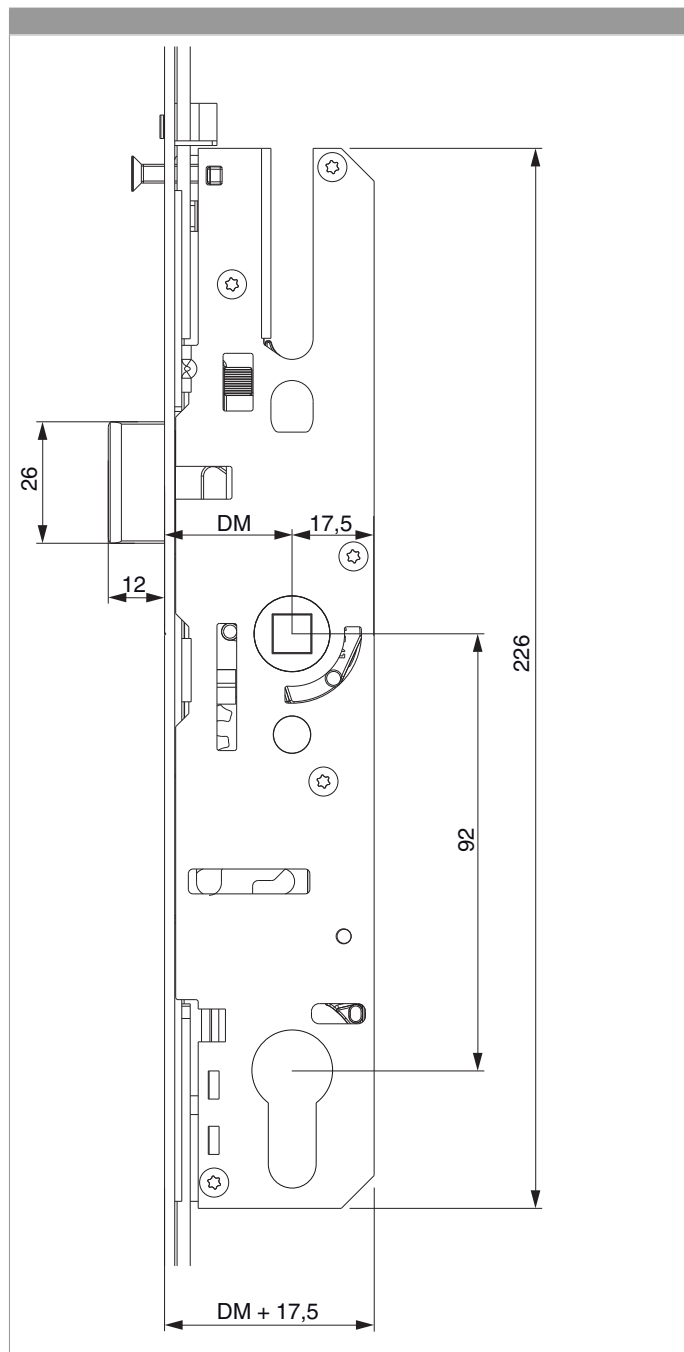



203831 - Serratura per portafinestra con scrocco con 2 funghi I92 per cilindro E45 argento MM L=1.347

Larghezza fresata per scatola serratura portafinestra min. 15,5 mm

Attenzione: Non aprire, in nessun caso, la scatola serratura!

Praticare tutte le forature prima del montaggio della serratura.

- Una martellina rosetta non può essere usato!
- Deve essere usato una martellina passante con maniglia interna e esterna!

Collegamento a clips

Agganciare collegamento a clips

①

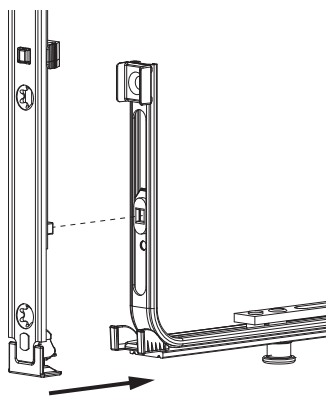

②

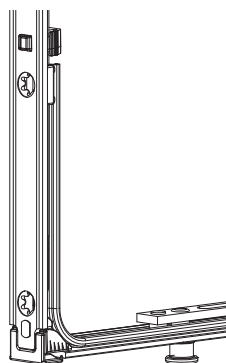

Sganciare collegamento clips

①

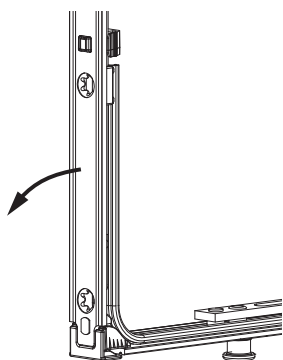

②

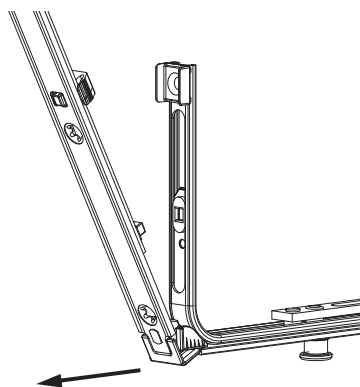

③

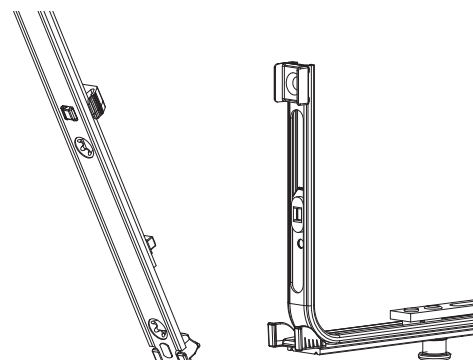



203831 - Serratura per portafinestra con scrocco con 2 funghi I92 per cilindro E45 argento MM L=1.347

Serrature comandate con maniglia

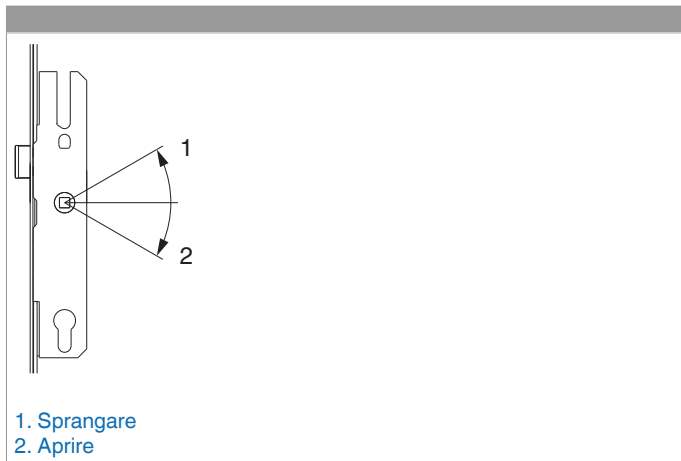

Scrocco reversibile

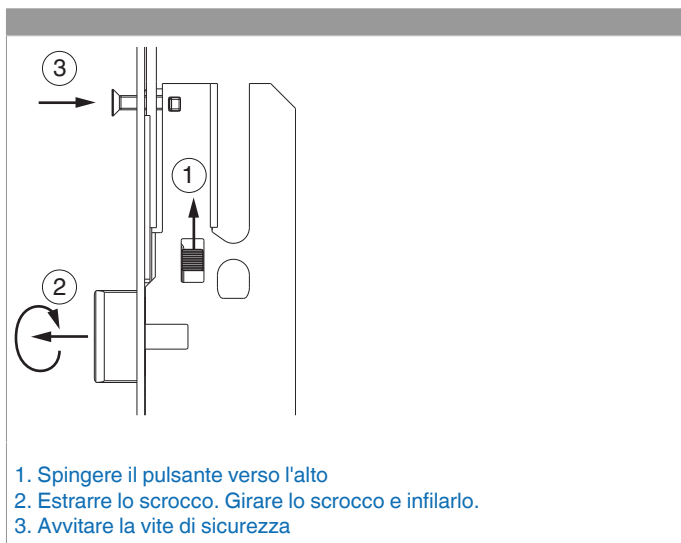



203831 - Serratura per portafinestra con scrocco con 2 funghi I92 per cilindro E45 argento MM L=1.347

Composizioni ferramenta

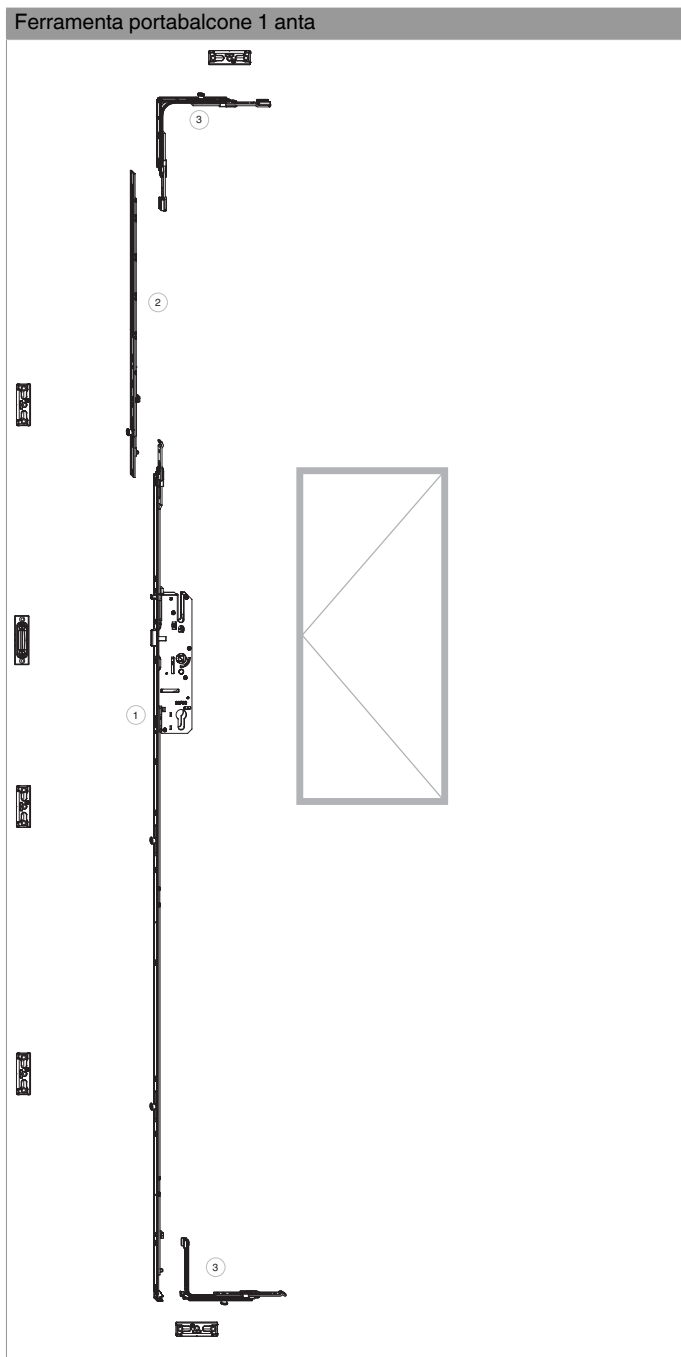



203831 - Serratura per portafinestra con scrocco con 2
funghi I92 per cilindro E45 argento MM L=1.347

Ferramenta portabalcone 2 ante con catenaccio

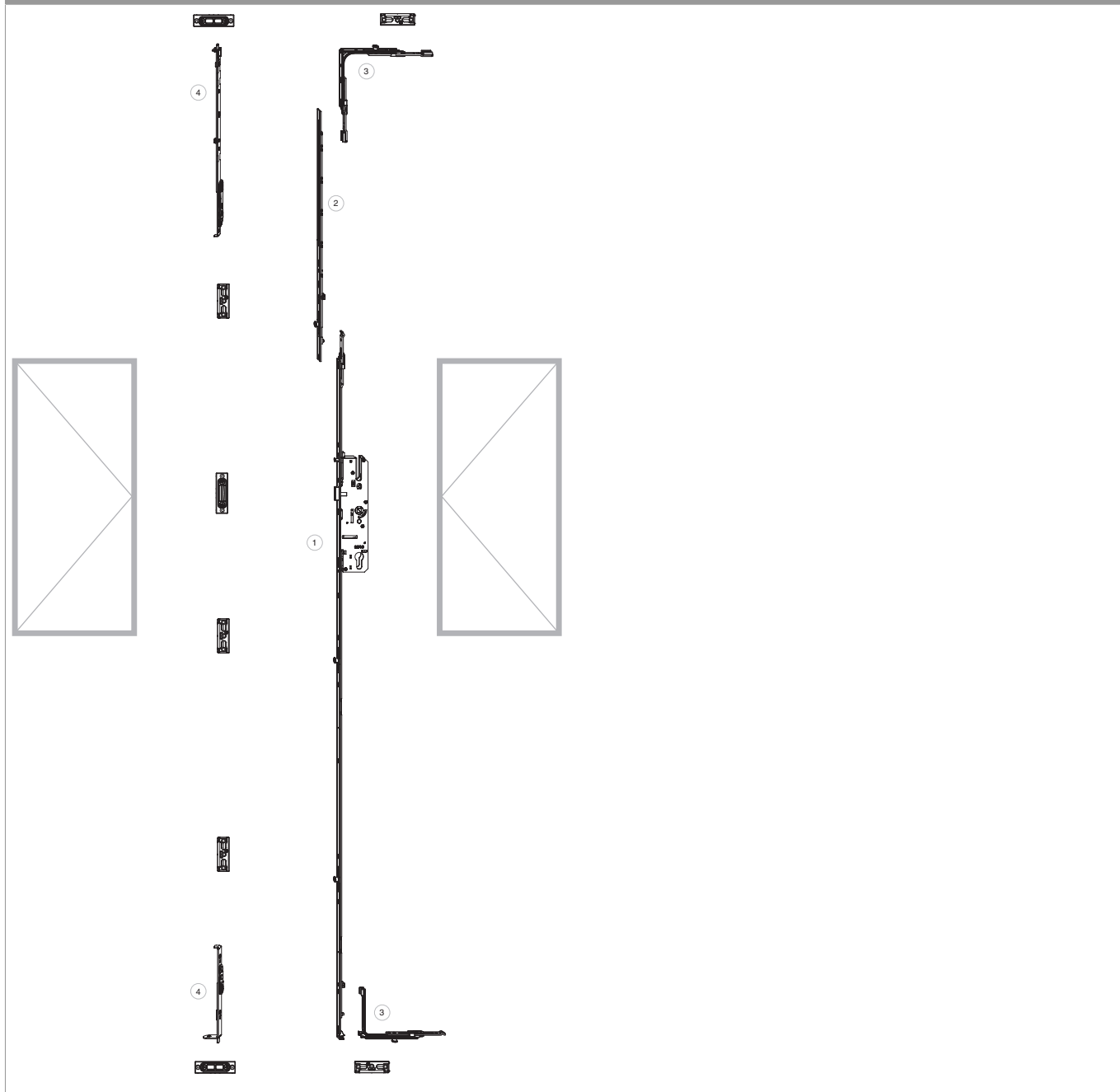



203831 - Serratura per portafinestra con scrocco con 2
funghi I92 per cilindro E45 argento MM L=1.347

Ferramenta portabalcone 2 ante con terminale

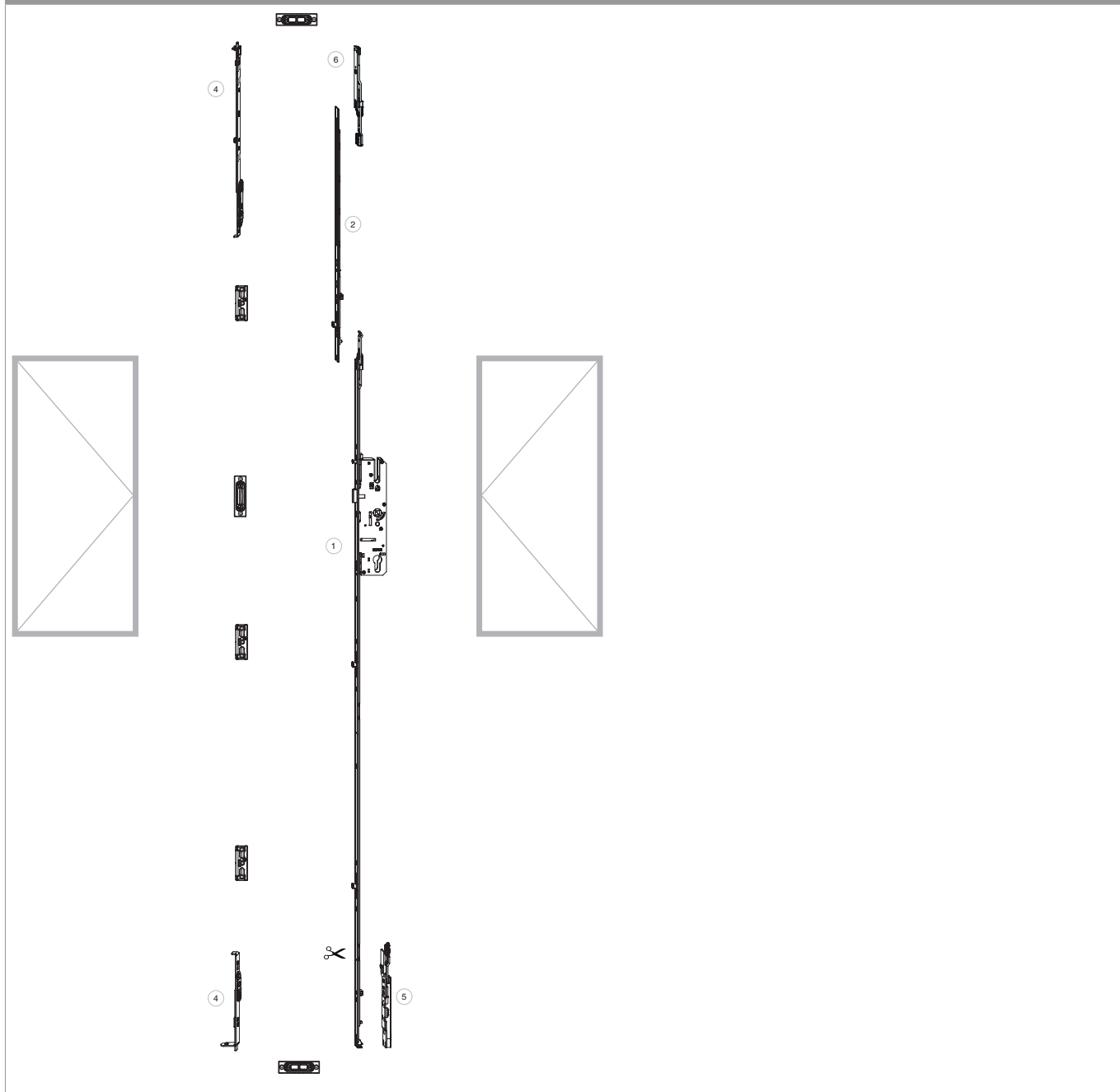



203831 - Serratura per portafinestra con scrocco con 2 funghi I92 per cilindro E45 argento MM L=1.347

Ferramenta portabalcone 2 ante con asta a leva

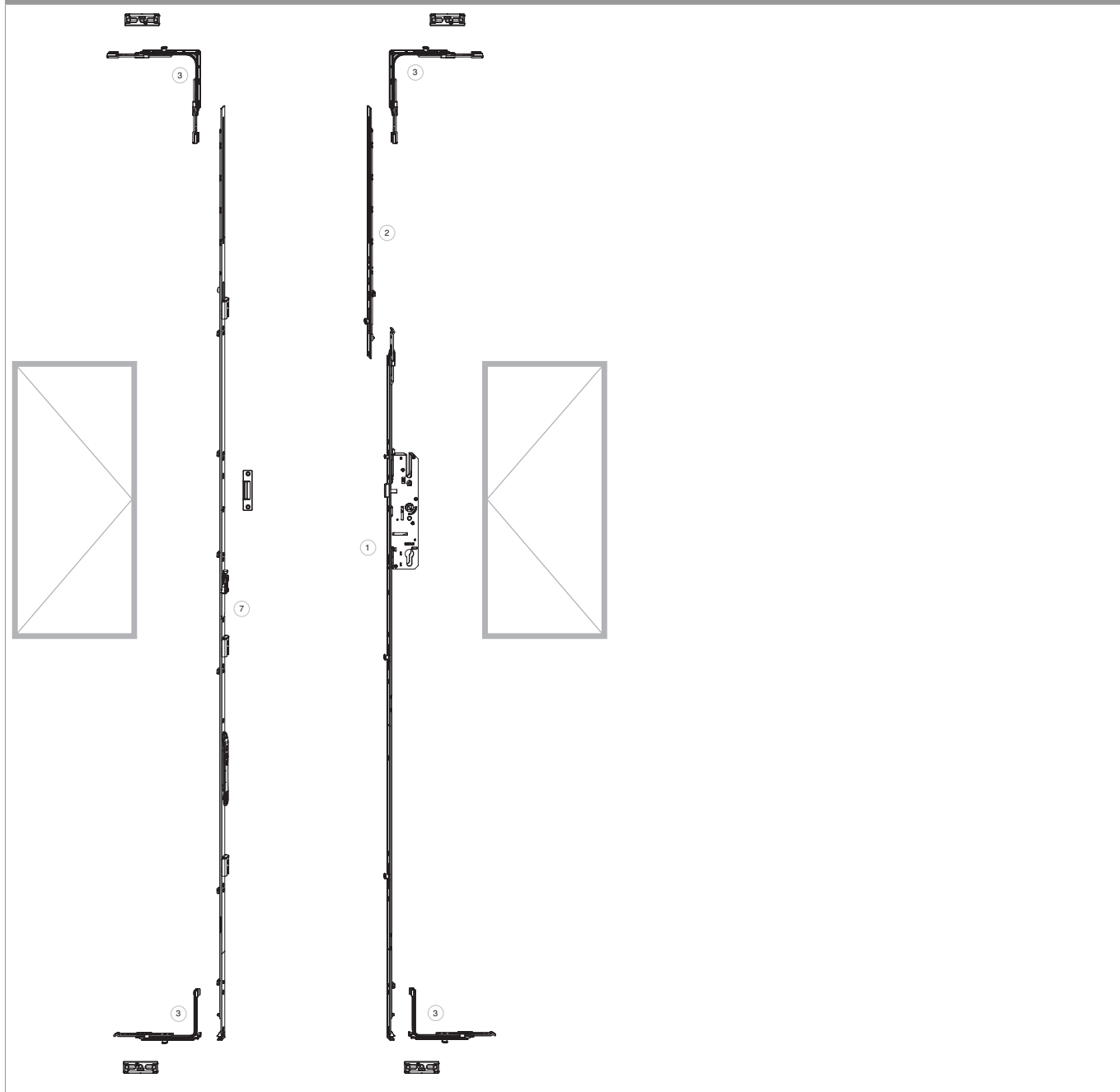



203831 - Serratura per portafinestra con scrocco con 2 funghi I92 per cilindro E45 argento MM L=1.347

Legenda

1. Serrature per portafinestra
2. Prolunghe frontali per portafinestra
3. Movimenti angolari
4. Catenaccio
5. Terminale inferiore Anta-Battente ad inversione con uscita puntale
6. Terminale per cremonese ad inversione superiore con uscita puntale
7. Asta a leva fix per cava ferramenta

Regolazione pressione

