

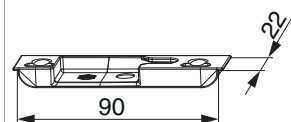

357673 - Scontro fungo per A4 scost. 13 mm con vite inclinata destro argento

Disegni tecnici



			L	B	H			N ^o
argento	destro	Scontro fungo per A4 scost. 13 mm con vite inclinata	90	22	8	3	100	357673 ¹⁾

¹⁾ Per porte destre usare scontri sinistri e viceversa!

Posizionamento degli scontri

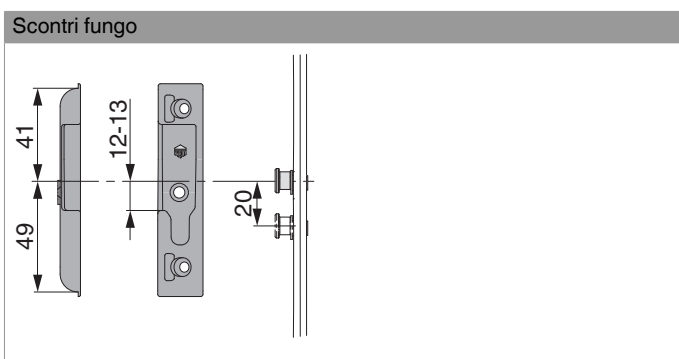

Schema foro e fresata

