

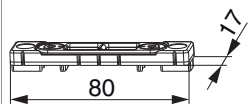

23886 - Scontro catenaccio canalino euro 2 fori argento

Disegni tecnici



		L	B	H		N ^o
argento	2 fori	80	17	6,5	100	23886

Dime

			N ^o
Dima completa con guidascontro scontro catenaccio telescopica autocentrante MM-bilanciere	2 ante	1	213865

Sezioni profilo

A12 Euronut 7/8/4 - 1 anta

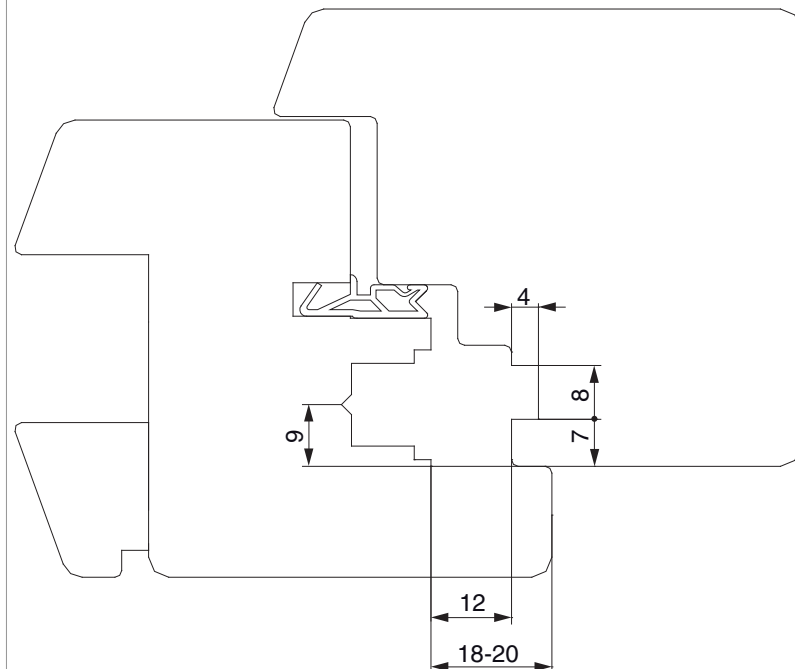

A12 Euronut 7/8/4 - 2 ante

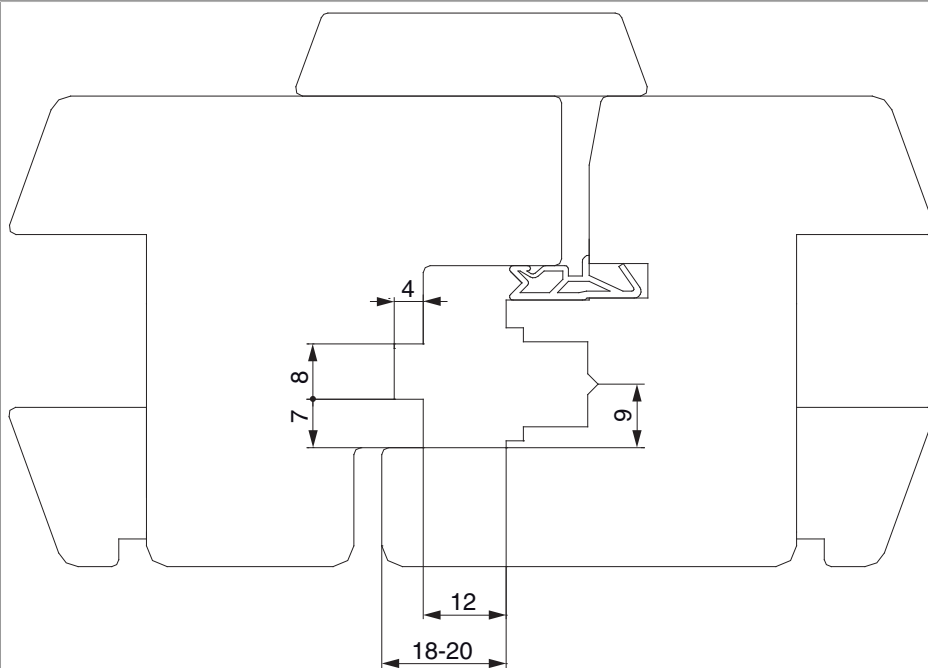

Costruzione alternativa della finestra 1 anta

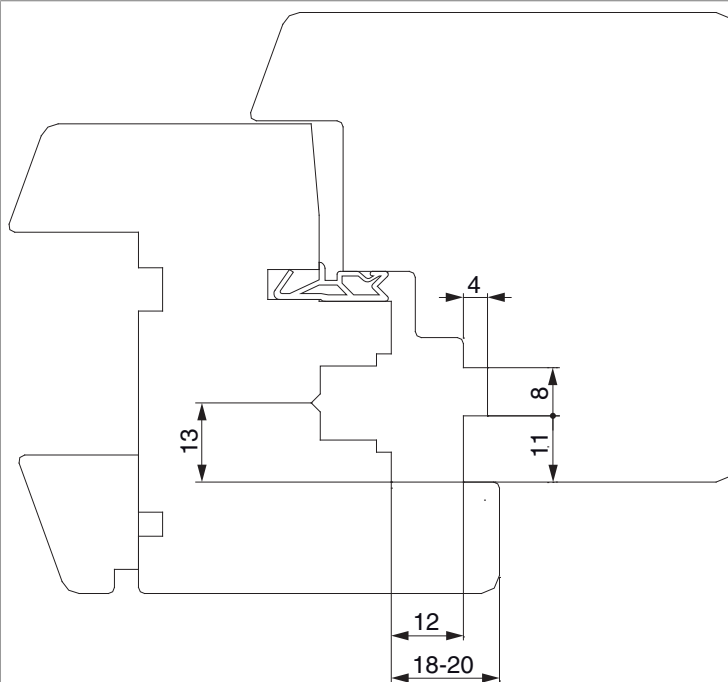

Costruzione alternativa della finestra 2 ante

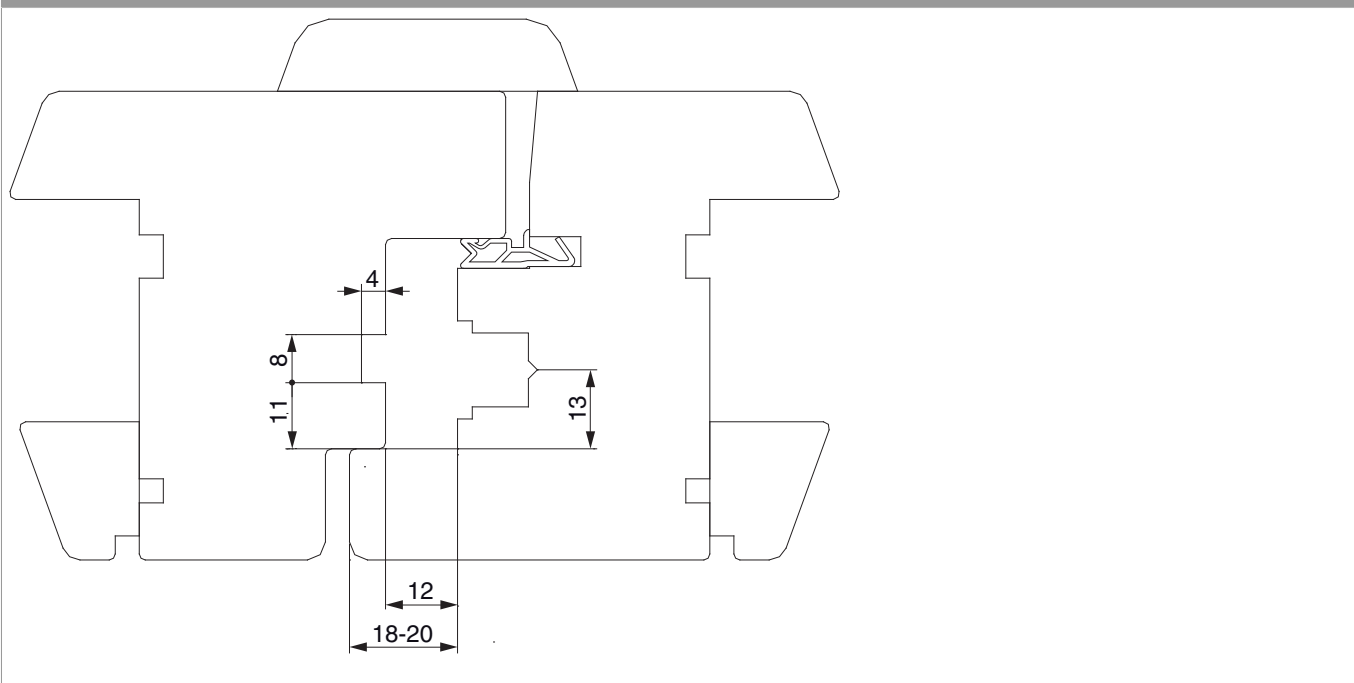

Posizionamento degli scontri

Finestra a 2 ante con 1 catenaccio

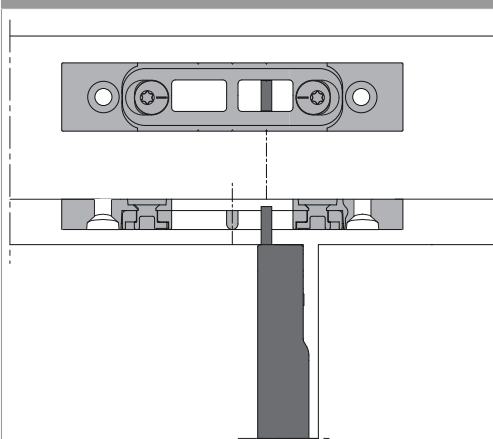

Allineare il centro dell'uscita puntale alla tacca

Finestra a 2 ante con 2 catenacci

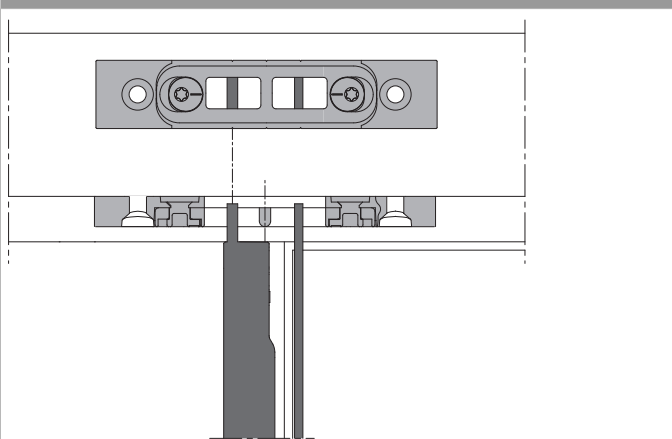

Centro scontro = centro cava ferramenta

Regolazione pressione

sullo scontro

