

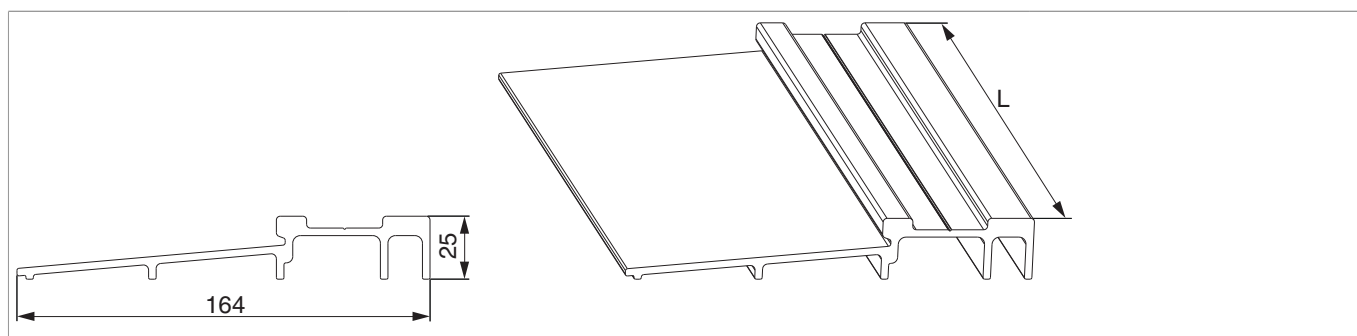



## 462535 - Soglia HS in vetroresina S=164 mm H=25 mm L=5.000mm argento

### Disegni tecnici



			L		No
Soglia HS in vetroresina	argento	S=164 mm H=25 mm	5.000	1	462535