

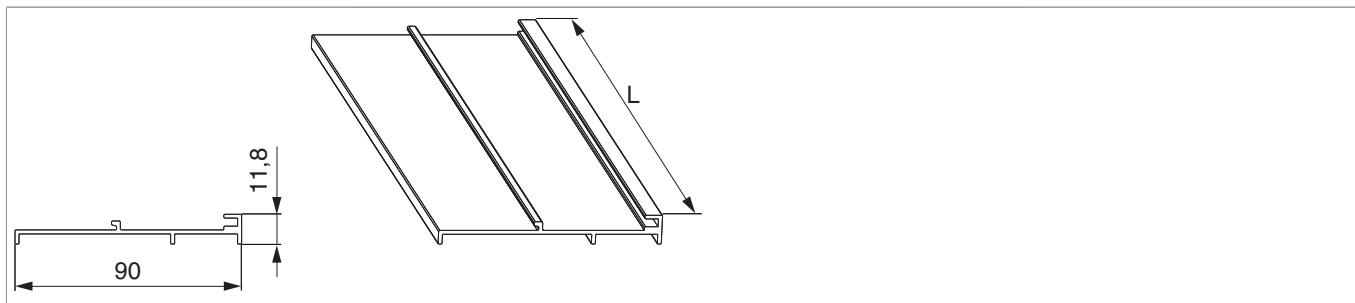

## 457350 - Gocciolatoio HS-P in alluminio L=5.000 argento

### Disegni tecnici



		L		Nº
	argento	5.000	1	457350

### Montaggio gocciolatoio

