

457133 - Guarnizione anta per Transit estensibile AB10 F1 L=2.500mm

Disegni tecnici

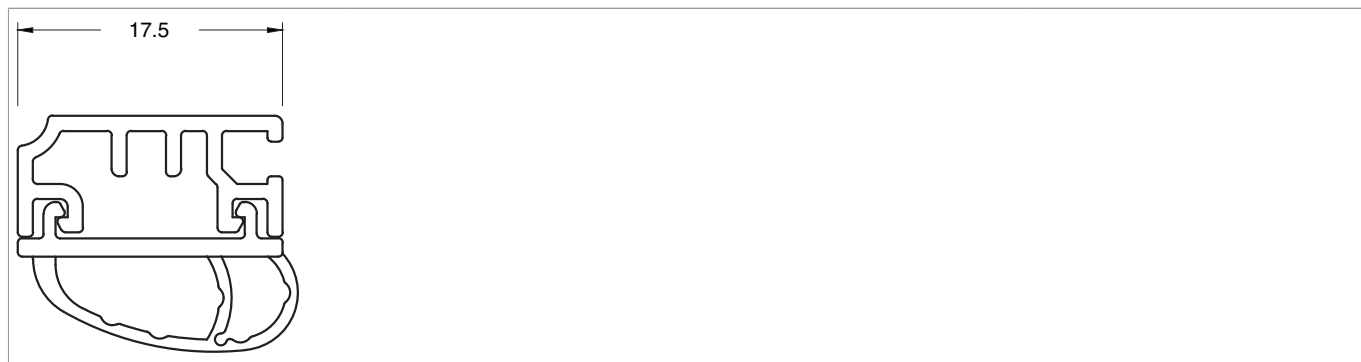

			L		Nº
	F1	AB10	2.500	10	457133

Montaggio guarnizione

Finestra con 1 anta

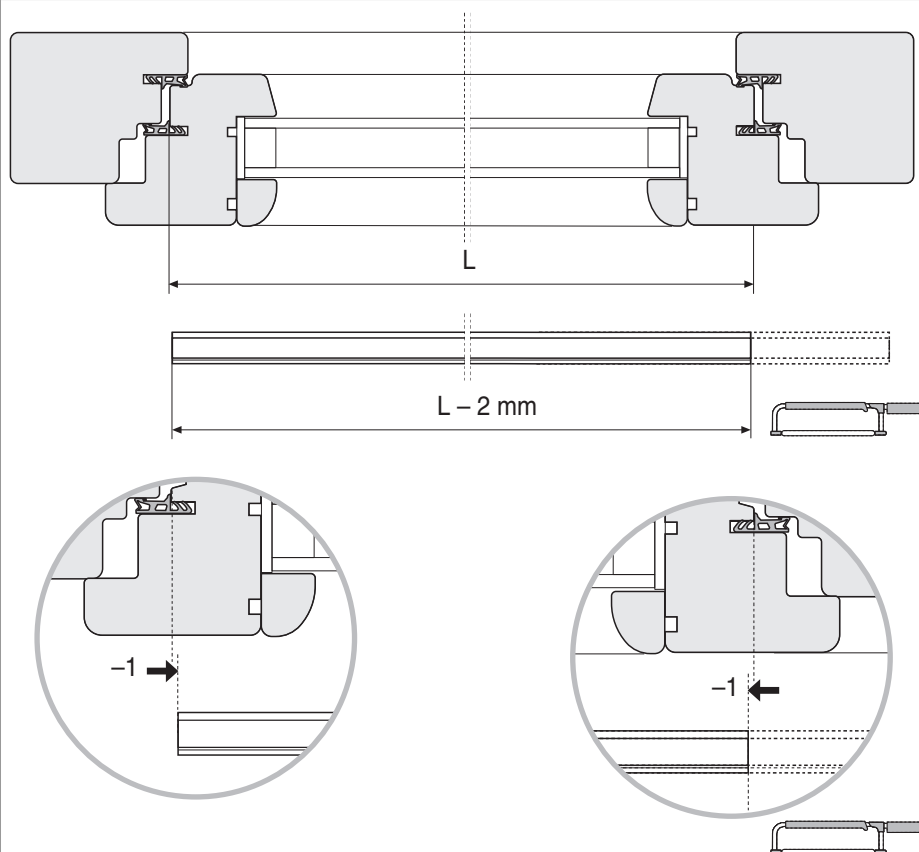

Tagliare la guarnizione

Finestra con 2 ante

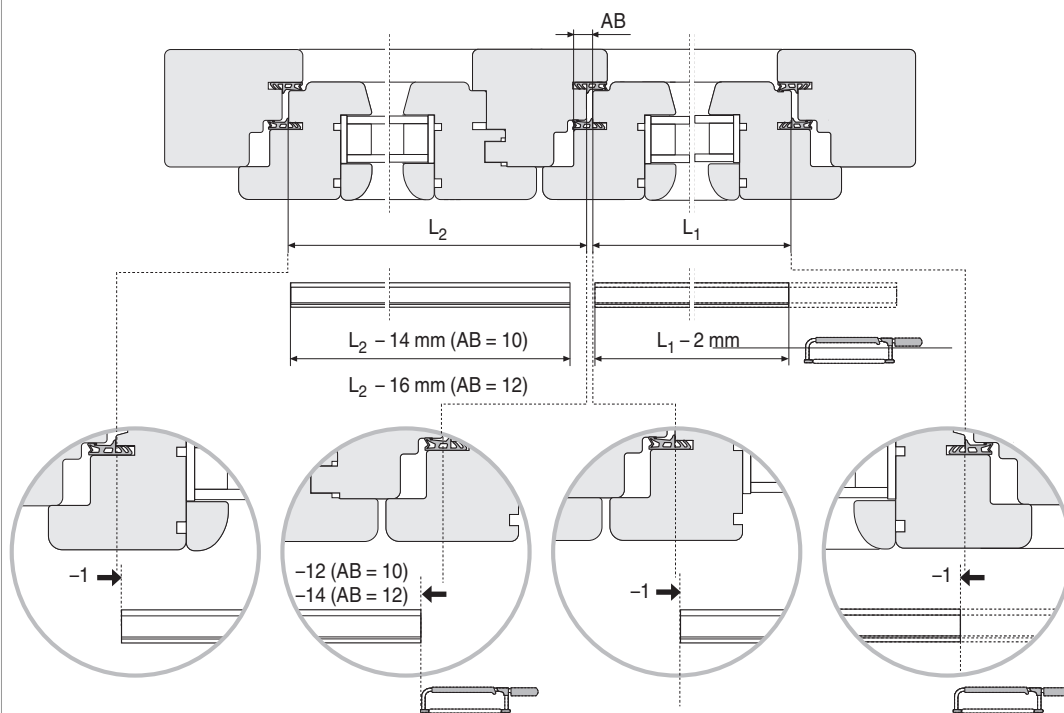

Tagliare la guarnizione

Finestra con 1 anta

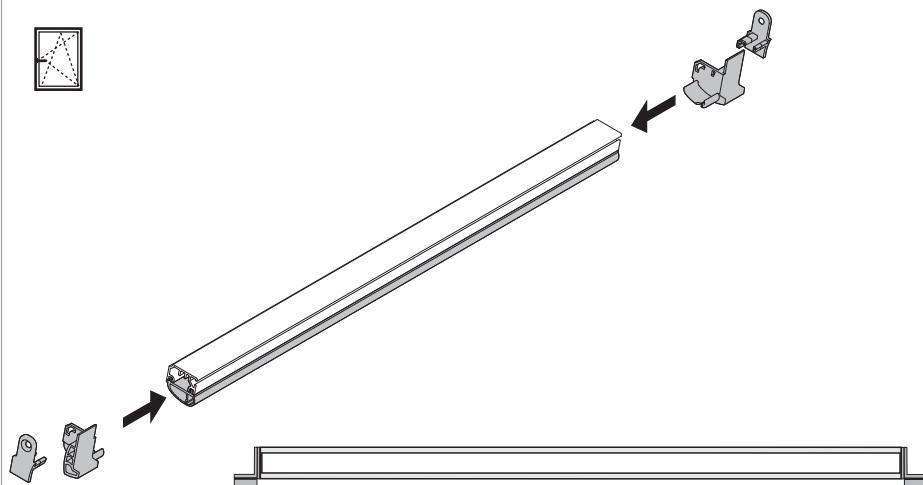

Montare i terminali

Finestra con 2 ante

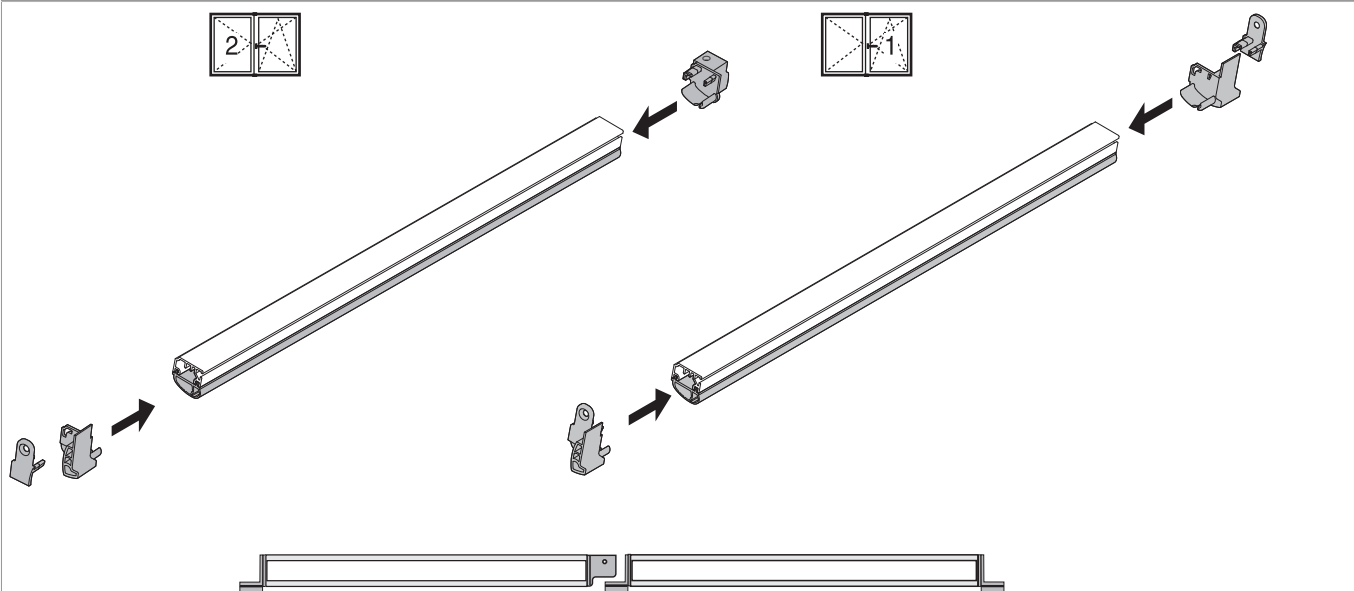

Montare i terminali

Fissare la guarnizione sull'anta coll'adesivo

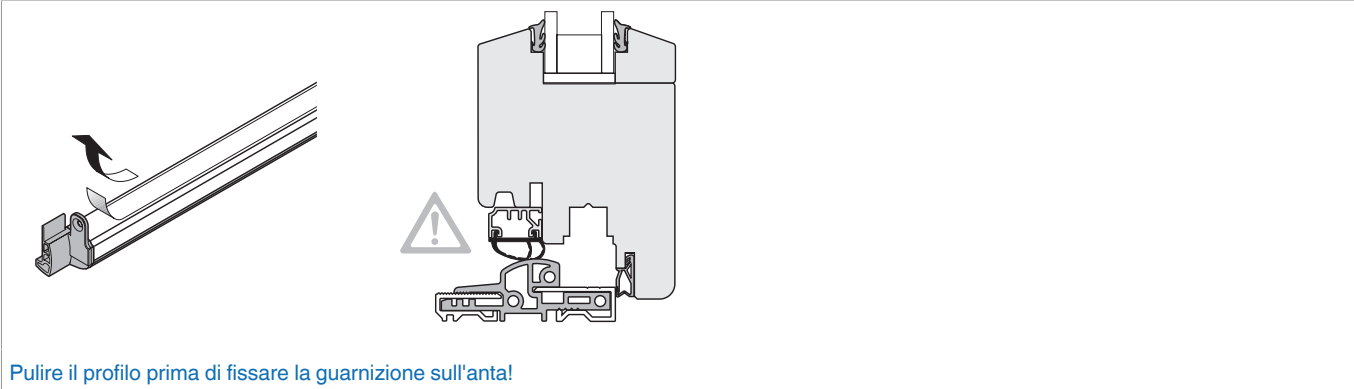

Pulire il profilo prima di fissare la guarnizione sull'anta!

Staccare la guarnizione con una cacciavite dal profilo

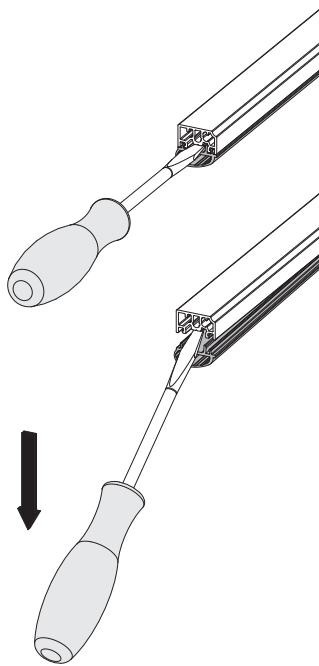

Avvitare il profilo della guarnizione sull'anta

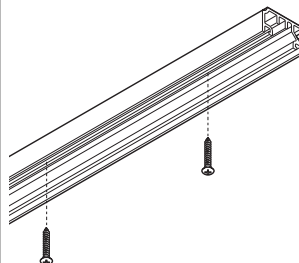

Agganciare la guarnizione nel profilo

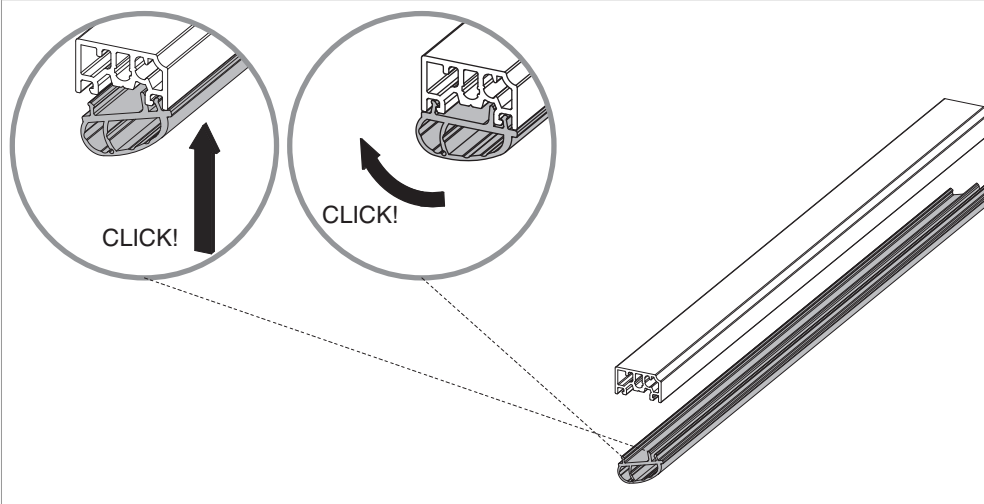

**MACO
TRANSIT**



**457133 - Guarnizione anta per Transit estensibile AB10 F1
L=2.500mm**

Avvitare i terminali sull'anta

