

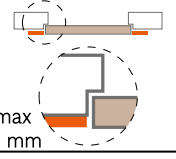

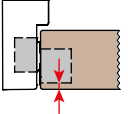

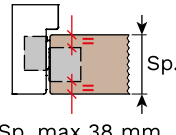

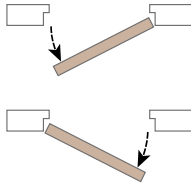
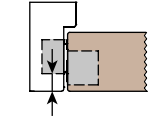

# KUBICA K6360 38 HYBRID

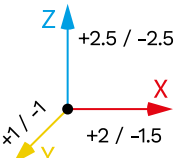
PATENTED

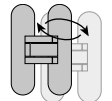
<p><b>MATERIALE</b></p> <p>Carcassa: Acciaio Corpi: Zama Bielle: Zama</p>	<p><b>PORTATA</b> 60 kg (2 cerniere)</p> 	<p><b>APPLICAZIONE</b> Filo cornice (Disassata)</p>  <p>max 12 mm</p>	<p><b>MISURA K</b></p>  <p>K-max 4 mm</p>
<p><b>CERNIERA CENTRATA</b></p>  <p>Sp. max 38 mm</p>		 <p>max 12 mm</p>	<p><b>ANGOLO DI APERTURA</b> 180°</p> 
<p><b>REGOLAZIONE 3D</b></p>  <p>Z +2.5 / -2.5 X +2 / -1.5 Y +1 / -1</p>	<p><b>FINITURA</b> Full HD</p> 	<p><b>INTERCAMBIABILE CON:</b> K6380 38</p> 	<p><b>MATERIALE COVER</b> Acciaio</p> 
<p><b>NUMERO FULCRI</b> 5</p> 	<p>Test report</p>  <p>UNI EN1191:2012 Windows and doors Resistance to opening and closing</p> <p>Internal door with hinges mod. K6360 38/45 Total door weight: 60kg</p>		<p><b>MADE IN ITALY</b></p> 

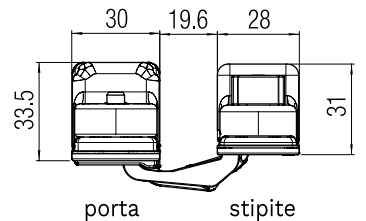
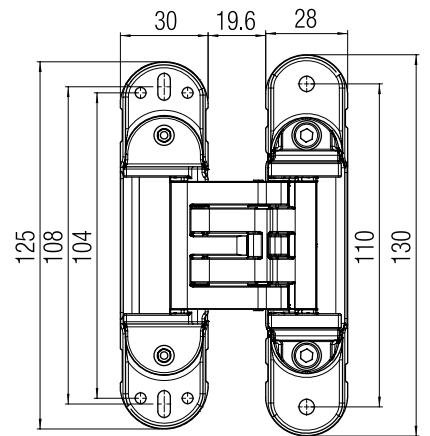

Finiture	
Colore	Codice art.
	Cromo lucido <b>K 6360 38 CL</b>
	Cromo satinato <b>K 6360 38 CS</b>
	Nichel satinato <b>K 6360 38 NS</b>
	Oro lucido <b>K 6360 38 OL</b>
	Oro satinato <b>K 6360 38 OS</b>
	Bronzo <b>K 6360 38 BR</b>
	Ottone lucido <b>K 6360 38 OTL</b>
	Bianco <b>K 6360 38 BI</b>
	Nero <b>K 6360 38 NR</b>

Per finiture differenti contatta Krona Koblenz per fattibilità



**Tabella di portata** (vedi pagina 12 per la guida alla lettura)

K6360 38 - 60 Kg - N° 2 cerniere												
Interasse cerniere (mm)**	2000	60	60	60	60	60	60	60	60	60	58	56
	1950	60	60	60	60	60	60	60	60	60	59	56
	1900	60	60	60	60	60	60	60	60	60	57	55
	1850	60	60	60	60	60	60	60	60	60	58	56
	1800	60	60	60	60	60	60	60	59	56	54	52
	1750	60	60	60	60	60	60	60	57	55	53	51
	1700	60	60	60	60	60	60	58	56	53	51	49
	1650	60	60	60	60	60	60	57	54	52	50	48
	1600	60	60	60	60	60	60	58	55	52	50	48
	1550	60	60	60	60	59	56	53	51	49	47	45
	1500	60	60	60	57	54	52	49	47	45	43	42
1450	60	60	58	55	52	50	48	45	44	42	40	
1540	60											
	926	700	800	900	950	1000	1050	1100	1150	1200	1250	1300
	Larghezza pannello (mm)**											

Specifiche di test:

- 2 cerniere: Interasse cerniere 1540 mm - Larghezza pannello 926 mm - Angolo di apertura 0°-90°.

\*\*Con pannello di dimensioni ed angolo max di apertura differenti dalla configurazione testata e/o con l'applicazione congiunta di altri dispositivi quali, ad esempio, chiudiporta/paracolpi/maniglione antipanic/guarnizione a ghigliottina/ecc. fare riferimento agli "Esempi di installazione". Si ricorda che i test per queste configurazioni sono a cura e sotto la responsabilità del cliente. Specifichiamo che le combinazioni e i valori di portata sono frutto di interpolazione e non di test reale, che rimane a cura e sotto la responsabilità del cliente.

**Quote applicazione standard**

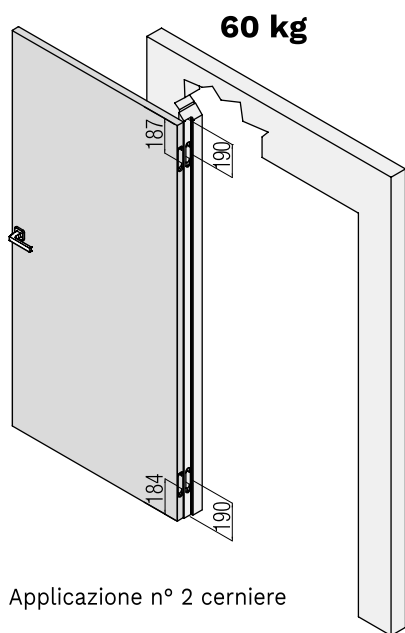

Applicazione n° 2 cerniere

**Fresata porta/stipite**

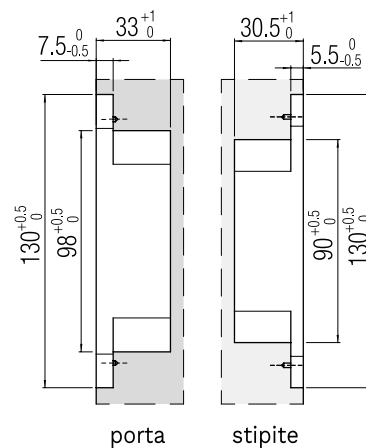

**Installazione cerniera centrata**

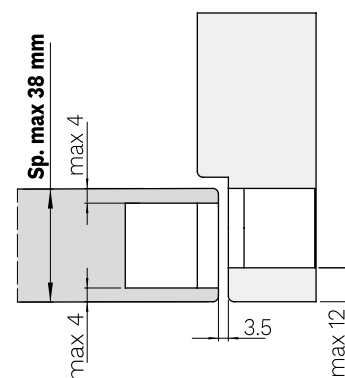

**Installazione cerniera NON centrata**

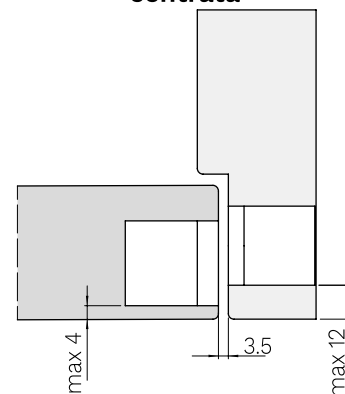

**Viti per fissaggio incluse**

Il fissaggio della cerniera è garantito utilizzando le **viti di fissaggio** indicate nelle istruzioni di montaggio della cerniera.